

(NL) MONTAGEVOORSCHRIFT (F) INSTRUCTIONS DE MONTAGE

(D) MONTAGE-ANLEITUNG (E) MOUNTING INSTRUCTIONS

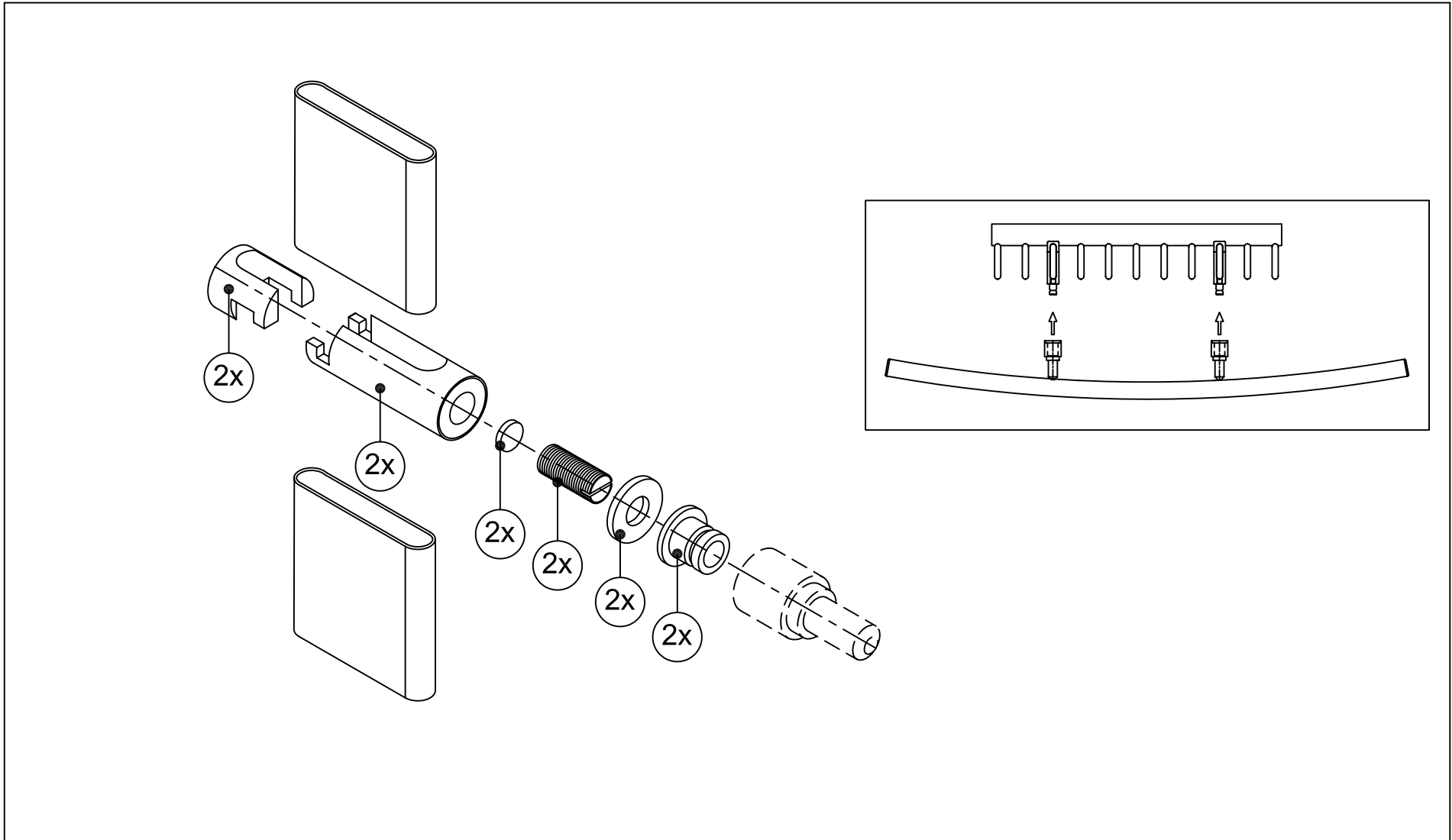

Art. nr. 4216

1

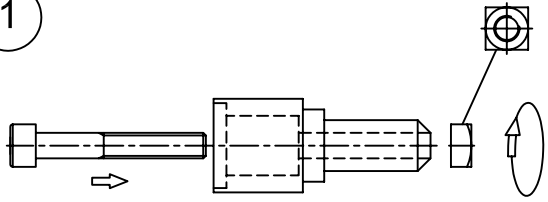

2

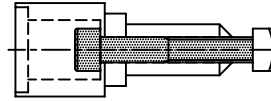

3

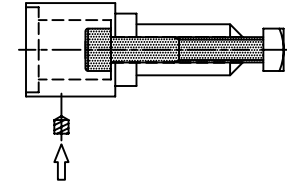

4

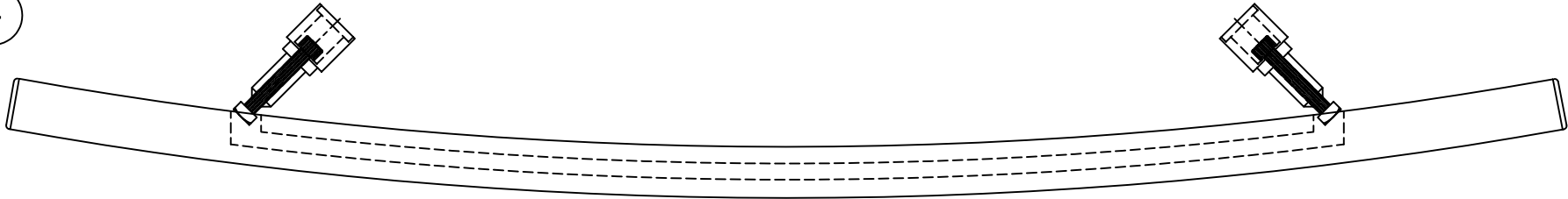

5

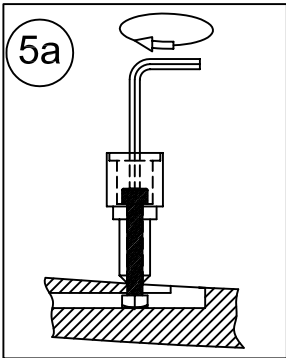
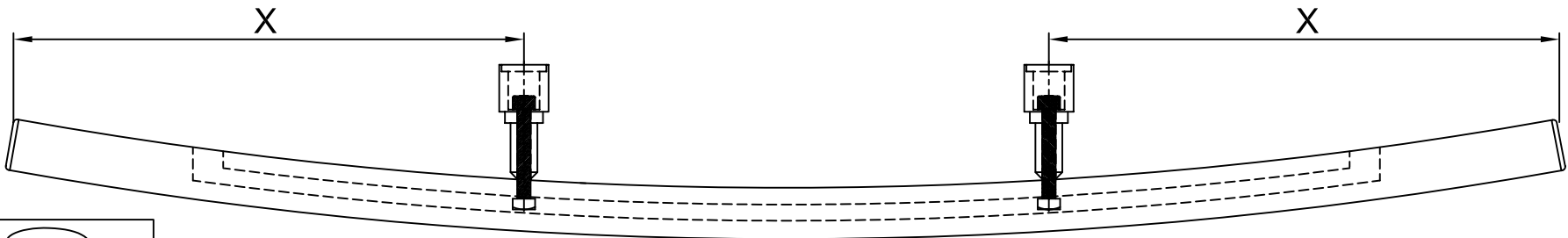

X = Type T/NVR paar buizen (198mm)
 X = Typ T/NVR paarige Rohre (198mm)
 X = Type T/NVR des tubes pairs (198mm)
 X = Type T/NVR even tubes (198mm)

X = Type T/NVR onpaar buizen (173mm)
 X = Typ T/NVR nicht paarige Rohre (173mm)
 X = Type T/NVR des tubes impairs (173mm)
 X = Type T/NVR unpaired tubes (173mm)

X = Type TSN/NVRSN (200mm)
 X = Typ TSN/NVRSN (200mm)
 X = Type TSN/NVRSN (200mm)
 X = Type TSN/NVRSN (200mm)